

▶ BEB351010M
BEB351010W

EN User Manual
Oven

USER MANUAL



AEG

CONTENTS

1. SAFETY INFORMATION.....	2
2. SAFETY INSTRUCTIONS.....	4
3. PRODUCT DESCRIPTION.....	7
4. CONTROL PANEL.....	7
5. BEFORE FIRST USE.....	8
6. DAILY USE.....	8
7. CLOCK FUNCTIONS.....	10
8. USING THE ACCESSORIES.....	11
9. ADDITIONAL FUNCTIONS.....	12
10. HINTS AND TIPS.....	13
11. CARE AND CLEANING.....	29
12. TROUBLESHOOTING.....	32
13. ENERGY EFFICIENCY.....	34

FOR PERFECT RESULTS

Thank you for choosing this AEG product. We have created it to give you impeccable performance for many years, with innovative technologies that help make life simpler - features you might not find on ordinary appliances. Please spend a few minutes reading to get the very best from it.

Visit our website for:



Get usage advice, brochures, trouble shooter, service information:

www.aeg.com/webselfservice



Register your product for better service:

www.registeraeg.com



Buy Accessories, Consumables and Original spare parts for your appliance:

www.aeg.com/shop

CUSTOMER CARE AND SERVICE

Always use original spare parts.

When contacting our Authorised Service Centre, ensure that you have the following data available: Model, PNC, Serial Number.

The information can be found on the rating plate.

 Warning / Caution-Safety information

 General information and tips

 Environmental information

Subject to change without notice.

1. SAFETY INFORMATION

Before the installation and use of the appliance, carefully read the supplied instructions. The

manufacturer is not responsible for any injuries or damage that are the result of incorrect installation or usage. Always keep the instructions in a safe and accessible location for future reference.

1.1 Children and vulnerable people safety

- This appliance can be used by children aged from 8 years and above and persons with reduced physical, sensory or mental capabilities or lack of experience and knowledge if they have been given supervision or instruction concerning the use of the appliance in a safe way and understand the hazards involved.
- Children between 3 and 8 years of age and persons with very extensive and complex disabilities shall be kept away from the appliance unless continuously supervised.
- Children of less than 3 years of age should be kept away from the appliance unless continuously supervised.
- Do not let children play with the appliance.
- Keep all packaging away from children and dispose of it appropriately.
- Keep children and pets away from the appliance when it operates or when it cools down. Accessible parts may become hot during use.
- If the appliance has a child safety device, it should be activated.
- Children shall not carry out cleaning and user maintenance of the appliance without supervision.

1.2 General Safety

- Only a qualified person must install this appliance and replace the cable.
- **WARNING:** The appliance and its accessible parts become hot during use. Care should be taken to avoid touching heating elements.
- Always use oven gloves to remove or put in accessories or ovenware.

- Before carrying out any maintenance, disconnect the appliance from the power supply.
- **WARNING:** Ensure that the appliance is switched off before replacing the lamp to avoid the possibility of electric shock.
- Do not use the appliance before installing it in the built-in structure.
- Do not use a steam cleaner to clean the appliance.
- Do not use harsh abrasive cleaners or sharp metal scrapers to clean the glass door since they can scratch the surface, which may result in shattering of the glass.
- If the mains power supply cable is damaged, it must be replaced by the manufacturer, its Authorised Service Centre or similarly qualified persons to avoid an electrical hazard.
- To remove the shelf supports first pull the front of the shelf support and then the rear end away from the side walls. Install the shelf supports in the opposite sequence.

2. SAFETY INSTRUCTIONS

2.1 Installation



WARNING!

Only a qualified person must install this appliance.

- Remove all the packaging.
- Do not install or use a damaged appliance.
- Follow the installation instructions supplied with the appliance.
- Always take care when moving the appliance as it is heavy. Always use safety gloves and enclosed footwear.
- Do not pull the appliance by the handle.
- Install the appliance in a safe and suitable place that meets installation requirements.
- Keep the minimum distance from other appliances and units.
- Before mounting the appliance, check if the oven door opens without restraint.

- The appliance is equipped with an electric cooling system. It must be operated with the electric power supply.
- The built-in unit must meet the stability requirements of DIN 68930.

Cabinet minimum height (Cabinet under the worktop minimum height)	600 (600) mm
Cabinet width	550 mm
Cabinet depth	605 (580) mm
Height of the front of the appliance	594 mm
Height of the back of the appliance	576 mm
Width of the front of the appliance	549 mm

Width of the back of the appliance	548 mm
Depth of the appliance	567 mm
Built in depth of the appliance	546 mm
Depth with open door	1017 mm
Ventilation opening minimum size. Opening placed on the bottom rear side	550 x 20 mm
Mains supply cable length. Cable is placed in the right corner of the back side	1500 mm
Mounting screws	4 x 12 mm

2.2 Electrical connection



WARNING!

Risk of fire and electric shock.

- All electrical connections should be made by a qualified electrician.
- The appliance must be earthed.
- Make sure that the parameters on the rating plate are compatible with the electrical ratings of the mains power supply.
- Always use a correctly installed shockproof socket.
- Do not use multi-plug adapters and extension cables.
- Make sure not to cause damage to the mains plug and to the mains cable. Should the mains cable need to be replaced, this must be carried out by our Authorised Service Centre.
- Do not let mains cables touch or come near the appliance door or the niche below the appliance, especially when it operates or the door is hot.
- The shock protection of live and insulated parts must be fastened in such a way that it cannot be removed without tools.

- Connect the mains plug to the mains socket only at the end of the installation. Make sure that there is access to the mains plug after the installation.
- If the mains socket is loose, do not connect the mains plug.
- Do not pull the mains cable to disconnect the appliance. Always pull the mains plug.
- Use only correct isolation devices: line protecting cut-outs, fuses (screw type fuses removed from the holder), earth leakage trips and contactors.
- The electrical installation must have an isolation device which lets you disconnect the appliance from the mains at all poles. The isolation device must have a contact opening width of minimum 3 mm.
- This appliance is supplied with a main plug and a main cable.

2.3 Use



WARNING!

Risk of injury, burns and electric shock or explosion.

- This appliance is for household use only.
- Do not change the specification of this appliance.
- Make sure that the ventilation openings are not blocked.
- Do not let the appliance stay unattended during operation.
- Deactivate the appliance after each use.
- Be careful when you open the appliance door while the appliance is in operation. Hot air can release.
- Do not operate the appliance with wet hands or when it has contact with water.
- Do not apply pressure on the open door.
- Do not use the appliance as a work surface or as a storage surface.
- Open the appliance door carefully. The use of ingredients with alcohol can cause a mixture of alcohol and air.
- Do not let sparks or open flames to come in contact with the appliance when you open the door.

- Do not put flammable products or items that are wet with flammable products in, near or on the appliance.



WARNING!

Risk of damage to the appliance.

- To prevent damage or discoloration to the enamel:
 - do not put ovenware or other objects in the appliance directly on the bottom.
 - do not put aluminium foil directly on the bottom of cavity of the appliance.
 - do not put water directly into the hot appliance.
 - do not keep moist dishes and food in the appliance after you finish the cooking.
 - be careful when you remove or install the accessories.
- Discoloration of the enamel or stainless steel has no effect on the performance of the appliance.
- Use a deep pan for moist cakes. Fruit juices cause stains that can be permanent.
- This appliance is for cooking purposes only. It must not be used for other purposes, for example room heating.
- Always cook with the oven door closed.
- If the appliance is installed behind a furniture panel (e.g. a door) make sure the door is never closed when the appliance operates. Heat and moisture can build up behind a closed furniture panel and cause subsequent damage to the appliance, the housing unit or the floor. Do not close the furniture panel until the appliance has cooled down completely after use.

2.4 Care and cleaning



WARNING!

Risk of injury, fire, or damage to the appliance.

- Before maintenance, deactivate the appliance and disconnect the mains plug from the mains socket.

- Make sure the appliance is cold. There is the risk that the glass panels can break.
- Replace immediately the door glass panels when they are damaged. Contact the Authorised Service Centre.
- Be careful when you remove the door from the appliance. The door is heavy!
- Clean regularly the appliance to prevent the deterioration of the surface material.
- Clean the appliance with a moist soft cloth. Use only neutral detergents. Do not use abrasive products, abrasive cleaning pads, solvents or metal objects.
- If you use an oven spray, follow the safety instructions on its packaging.
- Do not clean the catalytic enamel (if applicable) with detergents.

2.5 Internal lighting



WARNING!

Risk of electric shock.

- The type of light bulb or halogen lamp used for this appliance is for household appliances only. Do not use it for house lighting.
- Before replacing the lamp, disconnect the appliance from the power supply.
- Use only lamps with the same specifications.

2.6 Service

- To repair the appliance contact the Authorised Service Centre.
- Use original spare parts only.

2.7 Disposal



WARNING!

Risk of injury or suffocation.

- Disconnect the appliance from the mains supply.
- Cut off the mains electrical cable close to the appliance and dispose of it.
- Remove the door catch to prevent children or pets from becoming trapped in the appliance.

3. PRODUCT DESCRIPTION

3.1 General overview

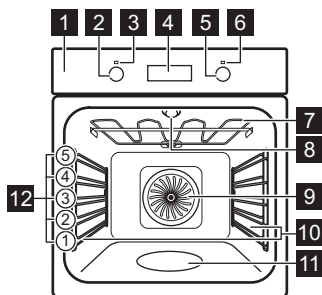

- 1 Control panel
- 2 Knob for the heating functions
- 3 Power lamp / symbol
- 4 Display
- 5 Control knob (for the temperature)
- 6 Temperature indicator / symbol
- 7 Heating element
- 8 Lamp
- 9 Fan
- 10 Shelf support, removable
- 11 Cavity embossment - Aqua cleaning container
- 12 Shelf positions

3.2 Accessories

Wire shelf

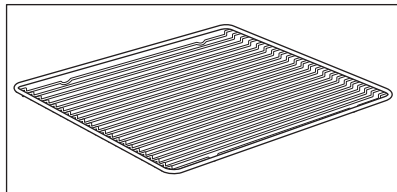

For cookware, cake tins, roasts.

Baking tray

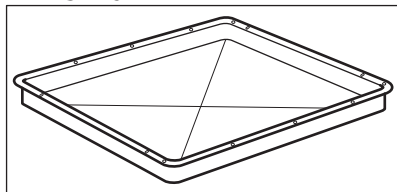

For cakes and biscuits.

Grill- / Roasting pan

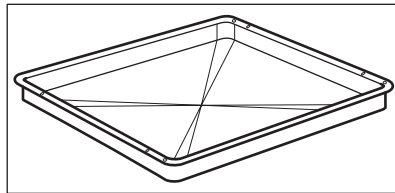

To bake and roast or as a pan to collect fat.

4. CONTROL PANEL

4.1 Buttons

Sensor field / Button	Function	Description
—	MINUS	To set the time.

Sensor field / Button	Function	Description
	CLOCK	To set a clock function.
+	PLUS	To set the time.

4.2 Display

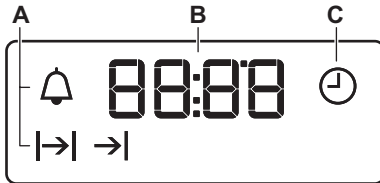

- A. Clock functions
- B. Timer
- C. Clock function

5. BEFORE FIRST USE



WARNING!
Refer to Safety chapters.



To set the Time of day refer to "Clock functions" chapter.

Refer to "Care and cleaning" chapter.

Clean the oven and the accessories before the first use.

Put the accessories and the removable shelf supports back to their initial position.

5.1 Initial Cleaning

Remove all accessories and removable shelf supports from the oven.

6. DAILY USE



WARNING!
Refer to Safety chapters.

6.1 Retractable knobs

To use the appliance press the knob. The knob comes out.

6.2 Setting a heating function





1. Turn the knob for the heating functions to select a heating function.
2. Turn the control knob to select the temperature.



The lamp turns on when the oven operates.

3. To turn off the oven, turn the knob for the heating functions to the off position.

6.3 Heating functions

Oven function	Application
0 Off position	The oven is off.
 Light	To turn on the lamp without a cooking function.

Oven function	Application
 True Fan Cooking	<p>To bake on up to three shelf positions at the same time and to dry food.</p> <p>Set the temperature 20 - 40 °C lower than for Conventional Cooking.</p>
 Pizza Function	<p>To bake pizza. To make intensive browning and a crispy bottom.</p>
 Conventional Cooking	<p>To bake and roast food on one shelf position.</p>
 Moist Baking	<p>This function is designed to save energy during cooking. For the cooking instructions refer to "Hints and tips" chapter, Moist Baking. The oven door should be closed during cooking so that the function is not interrupted and to ensure that the oven operates with the highest energy efficiency possible. When you use this function, the temperature in the cavity may differ from the set temperature. The heating power may be reduced. For general energy saving recommendations refer to "Energy Efficiency" chapter, Energy Saving. This function was used to comply with the energy efficiency class according to EN 60350-1.</p>
 Defrost	<p>To defrost food (vegetables and fruit). The defrosting time depends on the amount and size of the frozen food.</p>

Oven function	Application
 True Fan Cooking / True Fan Cooking PLUS / Aqua Cleaning	<p>To bake on up to three shelf positions at the same time and to dry food.</p> <p>Set the temperature 20 - 40 °C lower than for Conventional Cooking.</p> <p>To add humidity during the cooking. To get the right colour and crispy crust during baking. To give more juiciness during reheating.</p> <p>Refer to "Care and cleaning" chapter for more information about: Aqua Cleaning.</p>
 Grill	<p>To grill flat food and to toast bread.</p>
 Turbo Grilling	<p>To roast larger meat joints or poultry with bones on one shelf position. To make gratins and to brown.</p>

 The lamp may turn off automatically at a temperature below 60 °C during some oven functions.

6.4 Setting the function: True Fan Cooking PLUS

This function increases humidity during cooking.

 **WARNING!**
Risk of burns and damage to the appliance.

Released humidity can cause burns. After the function stops, carefully open the door.

1. Fill the cavity embossment with tap water.

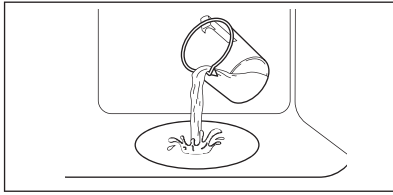

The maximum capacity of the cavity embossment is 250 ml. Fill the cavity embossment with water only when the oven is cold.



CAUTION!

Do not refill the cavity embossment during cooking or when the oven is hot.

2. Set the function: 
3. Turn the control knob to set temperature.

4. Preheat the empty oven for 10 minutes to create humidity.
5. Put food in the oven. Refer to "Hints and tips" chapter. Do not open the oven door during cooking.
6. Turn the knob for the heating functions to the off position to turn off the oven.
7. Remove water from the cavity embossment.







WARNING!

Make sure that the oven is cold before you remove the remaining water from the cavity embossment.

7. CLOCK FUNCTIONS

7.1 Clock functions table

Clock function	Application
 TIME OF DAY	To set, change or check the time of day.
 DURATION	To set how long the appliance operates.
 END	To set when the appliance deactivates.
 TIME DELAY	To combine DURATION and END function.
 MINUTE MINDER	To set countdown time. This function has no effect on the operation of the appliance. You can set the MINUTE MINDER at any time, also when the appliance is off.



7.2 Setting the time. Changing the time

You must set the time before you operate the oven.



The  flashes when you connect the appliance to the electrical supply, when there was a power cut or when the timer is not set.

Press the **+** or **-** to set the correct time.

After approximately five seconds, the flashing stops and the display shows the time of day you set.

To change the time of day press  again and again until  starts to flash.

7.3 Setting the DURATION

1. Set an oven function and temperature.
2. Press  again and again until  starts to flash.

3. Press **+** or **-** to set the DURATION time.

The display shows **|>|**.

4. When the time ends, **|>|** flashes and an acoustic signal sounds. The appliance deactivates automatically.
5. Press any button to stop the acoustic signal.
6. Turn the knob for the oven functions and the knob for the temperature to the off position.

7.4 Setting the END

1. Set an oven function and temperature.
2. Press **⌚** again and again until **→|** starts to flash.

3. Press **+** or **-** to set the time.

The display shows **→|**.

4. When the time ends, **→|** flashes and an acoustic signal sounds. The appliance deactivates automatically.
5. Press any button to stop the signal.
6. Turn the knob for the oven functions and the knob for the temperature to the off position.

7.5 Setting the TIME DELAY

1. Set an oven function and temperature.
2. Press **⌚** again and again until **|>|** starts to flash.
3. Press **+** or **-** to set the time for DURATION.
4. Press **⌚**.
5. Press **+** or **-** to set the time for END.

6. Press **⌚** to confirm.

Appliance turns on automatically later on, works for the set DURATION time and stops at the set END time. At the set time an acoustic signal sounds.

7. The appliance deactivates automatically. Press any button to stop the signal.
8. Turn the knob for the oven functions and the knob for the temperature to the off position.

7.6 Setting the MINUTE MINDER

1. Press **⌚** again and again until **🔔** starts to flash.
2. Press **+** or **-** to set the necessary time.

The Minute Minder starts automatically after 5 seconds.

3. When the set time ends, an acoustic signal sounds. Press any button to stop the acoustic signal.
4. Turn the knob for the oven functions and the knob for the temperature to the off position.

7.7 Cancelling the clock functions

1. Press the **⌚** again and again until the necessary function indicator starts to flash.
 2. Press and hold **-**.
- The clock function goes out after some seconds.

8. USING THE ACCESSORIES



WARNING!

Refer to Safety chapters.

8.1 Inserting the accessories

Wire shelf:

Push the shelf between the guide bars of the shelf support .

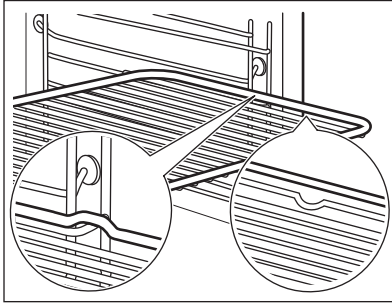

Baking tray/ Deep pan:

Push the baking tray / deep pan between the guide bars of the shelf support.

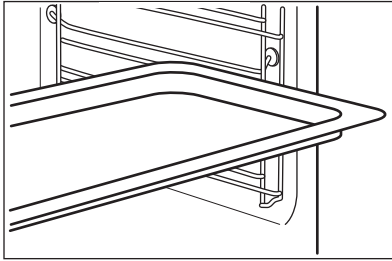

Wire shelf and baking tray / deep pan together:

Push the baking tray / deep pan between the guide bars of the shelf support and the wire shelf on the guide bars above.

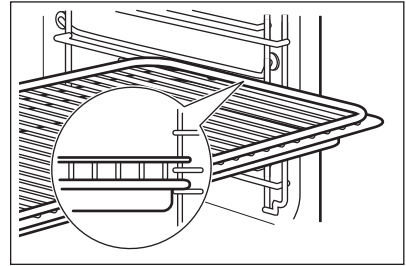

i Small indentation at the top increase safety. The indentations are also anti-tip devices. The high rim around the shelf prevents cookware from slipping of the shelf.

9. ADDITIONAL FUNCTIONS

9.1 Cooling fan

When the oven operates, the cooling fan turns on automatically to keep the surfaces of the oven cool. If you turn off the oven, the cooling fan can continue to operate until the oven cools down.

9.2 Mechanical door lock

The door lock is unlocked when you buy the oven.

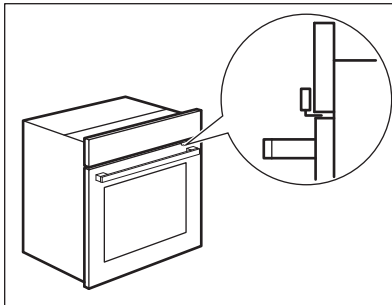

! **CAUTION!** Do not move the door lock vertically. Do not push the door lock when you close the oven door.

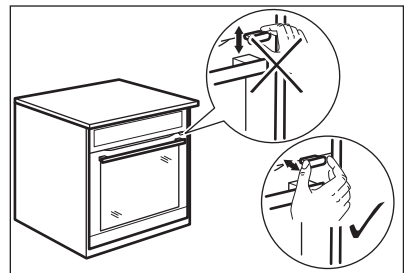

9.3 How to use mechanical door lock

1. To turn on the door lock pull the door lock forward until it locks in place.
2. To turn off the door lock push the door lock back into the panel.

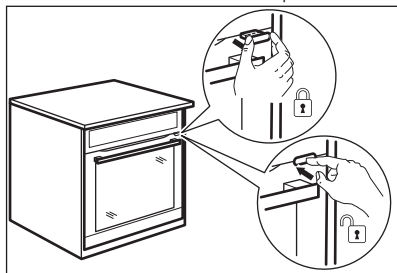

9.4 Opening the door with turned on mechanical door lock

You can open the door when the mechanical door lock is turned on.

1. Push the door lock slightly.
2. Open the door by pulling it with the handle.

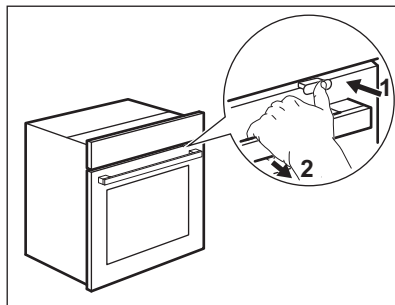

If you press the door lock until there is a click, you turn off the door lock.

10. HINTS AND TIPS



WARNING!
Refer to Safety chapters.



The temperature and baking times in the tables are guidelines only. They depend on the recipes and the quality and quantity of the ingredients used.

10.1 Cooking recommendations

Your oven may bake or roast differently to the oven you had before. The tables below show recommended settings for

Use a baking tray.

temperature, cooking time and shelf position for specific types of the food.

If you cannot find the settings for a special recipe, look for the similar one.





10.2 Inner side of the door

On the inner side of the door you can find:





- the numbers of the shelf positions.
- information about the oven functions, recommended shelf positions and temperatures for dishes.

10.3 True Fan Cooking PLUS

Use the second shelf position.



 CAKES / PASTRIES / BREADS			
	 (ml)	 (°C)	 (min)
Cookies / Scones / Croissants	100	150 - 180	10 - 20
Focaccia	100	200 - 210	10 - 20
Pizza	100	230	10 - 20
Bread rolls	100	200	20 - 25
Bread	100	180	35 - 40
Plum cake / Apple pie / Cinnamon rolls, baked in a cake mould	100 - 150	160 - 180	30 - 60



Use 150 ml of water unless specified otherwise.

 FROZEN READY MEALS			
	 (°C)	 (min)	
Pizza	200 - 210	10 - 20	
Croissants	170 - 180	15 - 25	
Lasagne, use 200 ml	180 - 200	35 - 50	

Use 100 ml of water.





Set the temperature to 110 °C.

 FOOD REGENERATION		
		 (min)
Bread rolls		10 - 20
Bread		15 - 25
Focaccia		15 - 25
Meat		15 - 25

 FOOD REGENERATION		
		 (min)
Pasta		15 - 25
Pizza		15 - 25
Rice		15 - 25
Vegetables		15 - 25

Use 200 ml of water.

Use a glass baking dish.

 ROASTING		
	 (°C)	 (min)
Roast beef	200	50 - 60
Chicken	210	60 - 80
Roast pork	180	65 - 80

10.4 Baking

Use the lower temperature the first time.

You can extend baking times by 10 – 15 minutes if you bake cakes on more than one shelf position.

Cakes and pastries at different heights do not always brown equally. There is no need to change the temperature setting







if an unequal browning occurs. The differences equalize during baking.







Trays in the oven can twist during baking. When the trays become cold again, the distortions disappear.







10.5 Tips on baking







Baking results	Possible cause	Remedy
The bottom of the cake is not baked sufficiently.	The shelf position is incorrect.	Put the cake on a lower shelf.
The cake sinks and becomes soggy or streaky.	The oven temperature is too high.	Next time set slightly lower oven temperature.
	The baking time is too short.	Next time set a longer baking time and lower oven temperature.
The cake is too dry.	The oven temperature is too low.	Next time set higher oven temperature.
	The baking time is too long.	Next time set shorter baking time.
The cake bakes unevenly.	The oven temperature is too high and the baking time is too short.	Set lower oven temperature and longer baking time.
	The cake batter is not evenly distributed.	Next time spread the cake batter evenly on the baking tray.
The cake is not ready in the baking time specified in a recipe.	The oven temperature is too low.	Next time set a slightly higher oven temperature.

10.6 Baking on one shelf level

 BAKING IN TINS				
		 (°C)	 (min)	
Flan base - short pastry, preheat the empty oven	True Fan Cooking	170 - 180	10 - 25	2
Flan base - sponge cake mixture	True Fan Cooking	150 - 170	20 - 25	2

 BAKING IN TINS				
		 (°C)	 (min)	
Ring cake / Brioche	True Fan Cooking	150 - 160	50 - 70	1
Madeira cake / Fruit cakes	True Fan Cooking	140 - 160	70 - 90	1
Cheesecake	Conventional Cooking	170 - 190	60 - 90	1

 CAKES / PASTRIES / BREADS		
 Use the third shelf position.		
 Use the function: True Fan Cooking.		
 Use a baking tray.		
	 (°C)	 (min)
Cake with crumble topping	150 - 160	20 - 40
Fruit flans (made of yeast dough / sponge cake mix- ture), use a deep pan	150	35 - 55

 CAKES / PASTRIES / BREADS		
 Use the third shelf position.		
 Use the function: True Fan Cooking.		
 Use a baking tray.		
	 (°C)	 (min)
Fruit flans made of short pastry	160 - 170	40 - 80



CAKES / PASTRIES / BREADS



Preheat the empty oven.



Use the function: Conventional Cooking.



Use a baking tray.



(°C)



(min)



Swiss roll	180 - 200	10 - 20	3
Rye bread:	first: 230	20	1
	then: 160 - 180	30 - 60	
Buttered almond cake / Sugar cakes	190 - 210	20 - 30	3
Cream puffs / Eclairs	190 - 210	20 - 35	3
Plaited bread / Bread crown	170 - 190	30 - 40	3
Fruit flans (made of yeast dough / sponge cake mixture), use a deep pan	170	35 - 55	3
Yeast cakes with delicate toppings (e.g. quark, cream, custard)	160 - 180	40 - 80	3
Christstollen	160 - 180	50 - 70	2



BISCUITS



Use the third shelf position.









(°C)







(min)

Short pastry biscuits	True Fan Cooking	150 - 160	10 - 20
-----------------------	------------------	-----------	---------

 BISCUITS			
 Use the third shelf position.			
		 (°C)	 (min)
Rolls, preheat the empty oven	True Fan Cooking	160	10 - 25
Biscuits made of sponge cake mixture	True Fan Cooking	150 - 160	15 - 20
Puff pastries, preheat the empty oven	True Fan Cooking	170 - 180	20 - 30
Biscuits made of yeast dough	True Fan Cooking	150 - 160	20 - 40
Macaroons	True Fan Cooking	100 - 120	30 - 50
Pastries made of egg white / Meringues	True Fan Cooking	80 - 100	120 - 150
Rolls, preheat the empty oven	Conventional Cooking	190 - 210	10 - 25





10.7 Bakes and gratins





 Use the first shelf position.			
		 (°C)	 (min)
Baguettes topped with melted cheese	True Fan Cooking	160 - 170	15 - 30
Vegetables au gratin, preheat the empty oven	Turbo Grilling	160 - 170	15 - 30
Lasagne	Conventional Cooking	180 - 200	25 - 40
Fish bakes	Conventional Cooking	180 - 200	30 - 60
Stuffed vegetables	True Fan Cooking	160 - 170	30 - 60
Sweet bakes	Conventional Cooking	180 - 200	40 - 60
Pasta bake	Conventional Cooking	180 - 200	45 - 60

10.8 Multilevel Baking

Use the baking trays.

Use the function: True Fan Cooking.

 CAKES / PASTRIES				
	 (°C)	 (min)		
			2 positions	
Cream puffs / Eclairs, preheat the empty oven	160 - 180	25 - 45	1 / 4	
Dry streusel cake	150 - 160	30 - 45	1 / 4	

 BISCUITS / SMALL CAKES / PASTRIES / ROLLS				
	 (°C)	 (min)		
			2 positions	3 positions
Rolls	180	20 - 30	1 / 4	-
Short pastry bis- cuits	150 - 160	20 - 40	1 / 4	1 / 3 / 5
Biscuits made of sponge cake mixture	160 - 170	25 - 40	1 / 4	-
Puff pastries, preheat the empty oven	170 - 180	30 - 50	1 / 4	-
Biscuits made of yeast dough	160 - 170	30 - 60	1 / 4	-
Macaroons	100 - 120	40 - 80	1 / 4	-
Biscuits made of egg white / Mer- ingues	80 - 100	130 - 170	1 / 4	-

10.9 Tips on Roasting

Use heat-resistant ovenware.

Roast lean meat covered.

Roast large meat joints directly in the tray or on the wire shelf placed above the tray.

Put some water in the tray to prevent dripping fat from burning.







Turn the roast after 1/2 - 2/3 of the cooking time.







Roast meat and fish in large pieces (1 kg or more).







Baste meat joints with their own juice several times during roasting.







10.10 Roasting







Use the first shelf position.







 BEEF				
			 (°C)	 (min)
Pot roast	1 - 1.5 kg	Conventional Cooking	230	120 - 150
Roast beef or fillet, rare, preheat the empty oven	per cm of thickness	Turbo Grilling	190 - 200	5 - 6
Roast beef or fillet, medium, preheat the empty oven	per cm of thickness	Turbo Grilling	180 - 190	6 - 8
Roast beef or fillet, well done, preheat the empty oven	per cm of thickness	Turbo Grilling	170 - 180	8 - 10







 PORK				
 Use the function: Turbo Grilling.				
	 (kg)	 (°C)	 (min)	
Shoulder / Neck / Ham joint	1 - 1.5	160 - 180	90 - 120	
Chops / Spare rib	1 - 1.5	170 - 180	60 - 90	
Meatloaf	0.75 - 1	160 - 170	50 - 60	
Pork knuckle, precooked	0.75 - 1	150 - 170	90 - 120	

 VEAL			
 Use the function: Turbo Grilling.			
	 (kg)	 (°C)	 (min)
Roast veal	1	160 - 180	90 - 120
Veal knuckle	1.5 - 2	160 - 180	120 - 150





 LAMB			
 Use the function: Turbo Grilling.			
	 (kg)	 (°C)	 (min)
Lamb leg / Roast lamb	1 - 1.5	150 - 170	100 - 120
Lamb saddle	1 - 1.5	160 - 180	40 - 60





 GAME			
 Use the function: Conventional Cooking.			
	 (kg)	 (°C)	 (min)
Saddle / Hare leg, preheat the empty oven	up to 1	230	30 - 40
Venison saddle	1.5 - 2	210 - 220	35 - 40
Haunch of venison	1.5 - 2	180 - 200	60 - 90





 POULTRY			
 Use the function: Turbo Grilling.			
	 (kg)	 (°C)	 (min)
Poultry, portions	0.2 - 0.25 each	200 - 220	30 - 50
Chicken, half	0.4 - 0.5 each	190 - 210	35 - 50
Chicken, poulard	1 - 1.5	190 - 210	50 - 70
Duck	1.5 - 2	180 - 200	80 - 100
Goose	3.5 - 5	160 - 180	120 - 180
Turkey	2.5 - 3.5	160 - 180	120 - 150
Turkey	4 - 6	140 - 160	150 - 240







 FISH (STEAMED)			
 Use the function: Conventional Cooking.			
	 (kg)	 (°C)	 (min)
Whole fish	1 - 1.5	210 - 220	40 - 60







10.11 Crispy baking with: Pizza Function

 PIZZA		
 Use the first shelf position.		
	 (°C)	 (min)
Tarts	180 - 200	40 - 55
Spinach flan	160 - 180	45 - 60

 PIZZA		
 Use the first shelf position.		
	 (°C)	 (min)
Quiche lor-raine / Swiss flan	170 - 190	45 - 55
Cheesecake	140 - 160	60 - 90

 PIZZA		
 Use the first shelf position.		
	 (°C)	 (min)
Vegetable pie	160 - 180	50 - 60

 PIZZA		
 Preheat the empty oven before cooking.		
 Use the second shelf position.		
	 (°C)	 (min)
Pizza, thin crust, use a deep pan	200 - 230	15 - 20
Pizza, thick crust	180 - 200	20 - 30







 PIZZA		
 Preheat the empty oven before cooking.		
 Use the second shelf position.		
	 (°C)	 (min)
Unleavened bread	230 - 250	10 - 20
Puff pastry flan	160 - 180	45 - 55
Flammkuchen	230 - 250	12 - 20
Pierogi	180 - 200	15 - 25







10.12 Grill

Preheat the empty oven before cooking.







Grill only thin pieces of meat or fish.

Put a pan on the first shelf position to collect fat.

 GRILL				
 Use the function: Grill				
	 (°C)	 (min) 1st side	 (min) 2nd side	
Roast beef	210 - 230	30 - 40	30 - 40	2
Beef fillet	230	20 - 30	20 - 30	3
Pork loin	210 - 230	30 - 40	30 - 40	2

 GRILL				
 Use the function: Grill				
	 (°C)	 (min) 1st side	 (min) 2nd side	
Veal loin	210 - 230	30 - 40	30 - 40	2
Lamb saddle	210 - 230	25 - 35	20 - 25	3
Whole fish, 0.5 kg - 1 kg	210 - 230	15 - 30	15 - 30	3 / 4

10.13 Frozen Foods

 DEFROSTING				
 Use the function: True Fan Cooking.				
	 (°C)	 (min)		
Pizza, frozen	200 - 220	15 - 25	2	
Pizza American, frozen	190 - 210	20 - 25	2	
Pizza, chilled	210 - 230	13 - 25	2	
Pizza snacks, frozen	180 - 200	15 - 30	2	
French fries, thin	200 - 220	20 - 30	3	
French fries, thick	200 - 220	25 - 35	3	
Wedges / Croquettes	220 - 230	20 - 35	3	
Hash browns	210 - 230	20 - 30	3	
Lasagne / Cannelloni, fresh	170 - 190	35 - 45	2	
Lasagne / Cannelloni, frozen	160 - 180	40 - 60	2	
Baked cheese	170 - 190	20 - 30	3	
Chicken wings	190 - 210	20 - 30	2	







10.14 Defrost

Remove the food packaging and put the food on a plate.

Do not cover the food, as this can extend the defrost time.

For large portions of food place an upturned empty plate on the bottom of

the oven cavity. Put the food in a deep dish and set it on top of the plate inside the oven. Remove the shelf supports if necessary.

 Use the first shelf position.				
	 (kg)	 (min) Defrosting time	 (min) Further defrosting time	
Chicken	1	100 - 140	20 - 30	Turn halfway through.
Meat, turn half-way through	1	100 - 140	20 - 30	Turn halfway through.
Trout	0.15	25 - 35	10 - 15	-
Strawberries	0.3	30 - 40	10 - 20	-
Butter	0.25	30 - 40	10 - 15	-
Cream, whip the cream when still slightly frozen in places	2 x 0.2	80 - 100	10 - 15	Whip the cream when still slightly frozen in places.
Gateau	1.4	60	60	-





10.15 Dehydrating - True Fan Cooking

Cover trays with grease proof paper or baking parchment.

For a better result, stop the oven halfway through the drying time, open the door and let it cool down for one night to complete the drying.

For 1 tray use the third shelf position.

For 2 trays use the first and fourth shelf position.

 VEGETABLES		
	 (°C)	 (h)
Beans	60 - 70	6 - 8
Peppers	60 - 70	5 - 6
Vegetables for soup	60 - 70	5 - 6
Mushrooms	50 - 60	6 - 8
Herbs	40 - 50	2 - 3



Set the temperature to 60 - 70 °C.

FRUIT	
	(h)
Plums	8 - 10
Apricots	8 - 10
Apple slices	6 - 8

FRUIT	
	(h)
Pears	6 - 9



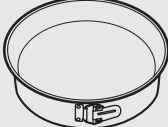

10.16 Moist Baking - recommended accessories



Use the dark and non-reflective tins and containers. They have better heat absorption than the light colour and reflective dishes.

			
Pizza pan	Baking dish	Ramekins	Flan base tin
Dark, non-reflective 28 cm diameter	Dark, non-reflective 26 cm diameter	Ceramic 8 cm diameter, 5 cm height	Dark, non-reflective 28 cm diameter

10.17 Moist Baking







For the best results follow suggestions listed in the table below.







		 (°C)		 (min)
Sweet rolls, 16 pieces	baking tray or dripping pan	190	3	45 - 55
Pizza, frozen, 0.35 kg	wire shelf	190	2	45 - 50
Swiss roll	baking tray or dripping pan	180	2	45 - 55
Brownie	baking tray or dripping pan	180	2	55 - 60







		 (°C)		 (min)
Sponge flan base	flan base tin on wire shelf	180	2	40 - 50
Poached fish, 0.3 kg	baking tray or dripping pan	180	3	25 - 35
Whole fish, 0.2 kg	baking tray or dripping pan	180	3	25 - 35
Fish fillet, 0.3 kg	pizza pan on wire shelf	180	3	40 - 50
Poached meat, 0.25 kg	baking tray or dripping pan	190	3	40 - 50
Shashlik, 0.5 kg	baking tray or dripping pan	190	3	35 - 45
Cookies, 16 pieces	baking tray or dripping pan	160	2	40 - 50
Macaroons, 24 pieces	baking tray or dripping pan	150	2	35 - 45
Muffins, 12 pieces	baking tray or dripping pan	160	2	35 - 45
Savory pastry, 20 pieces	baking tray or dripping pan	170	2	35 - 45
Short crust biscuits, 20 pieces	baking tray or dripping pan	150	2	40 - 45
Tartlets, 8 pieces	baking tray or dripping pan	170	2	35 - 45
Vegetables, poached, 0.4 kg	baking tray or dripping pan	180	3	45 - 55
Vegetarian omelette	pizza pan on wire shelf	190	3	40 - 50







10.18 Information for test institutes









Tests according to: EN 60350, IEC 60350.

 BAKING ON ONE LEVEL. Baking in tins					
		 (°C)	 (min)		
Fatless sponge cake	True Fan Cooking	140 - 150	35 - 50	2	
Fatless sponge cake	Conventional Cooking	160	35 - 50	2	
Apple pie, 2 tins Ø20 cm	True Fan Cooking	160	60 - 90	2	
Apple pie, 2 tins Ø20 cm	Conventional Cooking	180	70 - 90	1	

 BAKING ON ONE LEVEL. Biscuits					
 Use the third shelf position.					
		 (°C)	 (min)		
Short bread / Pastry strips	True Fan Cooking	140	25 - 40		
Short bread / Pastry strips, preheat the empty oven	Conventional Cooking	160	20 - 30		
Small cakes, 20 per tray, preheat the empty oven	True Fan Cooking	150	20 - 35		
Small cakes, 20 per tray, preheat the empty oven	Conventional Cooking	170	20 - 30		

 MULTILEVEL BAKING. Biscuits					
		 (°C)	 (min)		
				2 positions	3 positions
Short bread / Pastry strips	True Fan Cooking	140	25 - 45	1 / 4	1 / 3 / 5

 MULTILEVEL BAKING. Biscuits					
		 (°C)	 (min)	 2 posi- tions	 3 posi- tions
Small cakes, 20 per tray, preheat the empty oven	True Fan Cooking	150	23 - 40	1 / 4	-

 GRILL					
 Preheat the empty oven for 5 minutes.					
 Grill with the maximum temperature setting.					
		 (min)		 2 posi- tions	 3 posi- tions
Toast	Grill	1 - 3		5	
Beef steak, turn halfway through	Grill	24 - 30		4	

11. CARE AND CLEANING

 **WARNING!**
Refer to Safety chapters.

11.1 Notes on cleaning

	Clean the front of the oven with a soft cloth with warm water and a mild cleaning agent.
	To clean metal surfaces, use a dedicated cleaning agent.
	Clean stubborn stains with a special oven cleaner.

Cleaning Agents



Everyday Use

Clean the oven cavity after each use. Fat accumulation or other food remains may cause fire. The risk is higher for the grill pan.

Dry the cavity with a soft cloth after each use.



Accessories

Clean all accessories after each use and let them dry. Use a soft cloth with warm water and a cleaning agent. Do not clean the accessories in a dishwasher.

Do not clean the non-stick accessories using aggressive agents, sharp-edged objects or in a dishwasher.

11.2 Cleaning the cavity embossment

The cleaning procedure removes limestone residue from the cavity embossment after cooking with steam.



For the function: True Fan Cooking PLUS we recommend to do the cleaning procedure at least every 5 - 10 cooking cycles.

1. Put 250 ml of white vinegar into the cavity embossment at the bottom of the oven. Use maximum 6% vinegar without any additives.
2. Let the vinegar dissolve the residual limestone at the ambient temperature for 30 minutes.
3. Clean the cavity with warm water and a soft cloth.

11.3 How to remove: shelf supports

To clean the oven, remove the shelf supports.



CAUTION!

Be careful when you remove the shelf supports.

1. Pull the front of the shelf support away from the side wall.

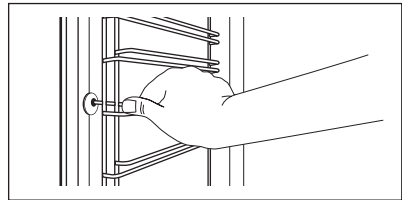

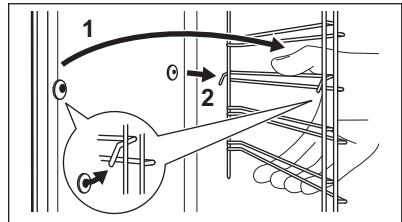

2. Pull the rear end of the shelf support away from the side wall and remove it.



Install the removed accessories in the opposite sequence.

11.4 Aqua Cleaning

This cleaning procedure uses humidity to help remove remaining fat and food particles from the oven.

1. Put 200 ml of water into the cavity embossment at the bottom of the oven.
2. Set the function:  
3. Set the temperature to 90 °C.
4. Let the oven operate for 30 minutes.
5. Turn off the oven.
6. When the oven is cold, dry the cavity with a soft cloth.

**WARNING!**

Make sure that the oven is cold before you touch it. There is a risk of burns.

11.5 How to remove: grill

**WARNING!**

There is a risk of burns.

1. Turn off the oven. Make sure that the oven is cold.
2. Remove the shelf supports.
3. Hold the grill with two hands at the front.
4. Grab the grill corners. Pull it forwards against the spring pressure and out of two holders.

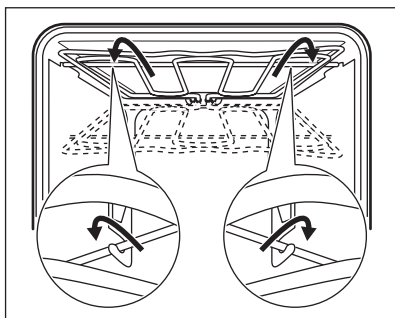

The grill folds down.

5. Clean the oven ceiling with warm water, a soft cloth and a mild detergent. Let it dry.
6. Install the grill in the opposite sequence.
7. Install the shelf supports.

11.6 Removing and installing the door

You can remove the door and the internal glass panels to clean it. The number of glass panels is different for different models.

**WARNING!**

The door is heavy.

1. Open the door fully.
2. Fully press the clamping levers (A) on the two door hinges.

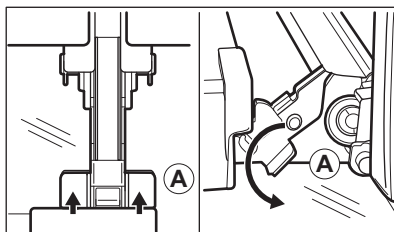

3. Close the oven door to the first opening position (approximately 70° angle).
4. Hold the door with one hand on each side and pull it away from the oven at an upwards angle.
5. Put the door with the outer side down on a soft cloth on a stable surface.
6. Hold the door trim (B) on the top edge of the door at the two sides and push inwards to release the clip seal.

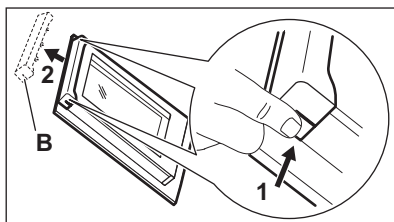

7. Pull the door trim to the front to remove it.
8. Hold the door glass panels on their top edge one by one and pull them up out of the guide.

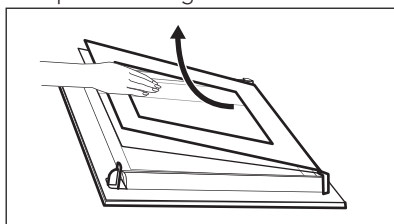

9. Clean the glass panel with water and soap. Dry the glass panel carefully. When the cleaning is completed, do the above steps in the opposite sequence. Install the smaller panel first, then the larger and the door.

- i** One of the hinge-arms (normally the right one) is free to move. Make sure, that both hinge-arms are in the same position (approximately 70° angle).

! **WARNING!**
Make sure that the glasses are inserted in the correct position otherwise the surface of the door may overheat.

11.7 How to replace: Lamp

! **WARNING!**
Risk of electric shock.
The lamp can be hot.

1. Turn off the oven. Wait until the oven is cold.
2. Disconnect the oven from the mains.
3. Put a cloth on the bottom of the cavity.

The top lamp

1. Turn the lamp glass cover to remove it.

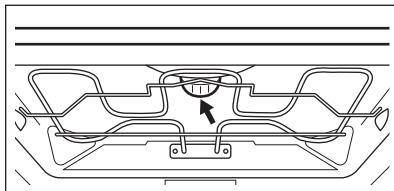

2. Clean the glass cover.
3. Replace the lamp with a suitable 300 °C heat-resistant lamp.
4. Install the glass cover.

12. TROUBLESHOOTING

! **WARNING!**
Refer to Safety chapters.

12.1 What to do if...

Problem	Possible cause	Remedy
You cannot activate or operate the oven. The display shows "400" and an acoustic signal sounds.	The oven is incorrectly connected to an electrical supply.	Check if the oven is correctly connected to the electrical supply (refer to the connection diagram if available).
The oven does not heat up.	The oven is deactivated.	Activate the oven.
The oven does not heat up.	The clock is not set.	Set the clock.
The oven does not heat up.	The necessary settings are not set.	Make sure that the settings are correct.
The oven does not heat up.	The fuse is blown.	Make sure that the fuse is the cause of the malfunction. If the fuse is blown again and again, contact a qualified electrician.
The lamp does not operate.	The lamp is defective.	Replace the lamp.

Problem	Possible cause	Remedy
Steam and condensation settle on the food and in the cavity of the oven.	You left the dish in the oven for too long.	Do not leave the dishes in the oven for longer than 15 - 20 minutes after the cooking process ends.
There is no good cooking performance using the function: True Fan Cooking PLUS.	You did not fill the cavity embossment with water.	Refer to "Setting the function: True Fan Cooking PLUS".
You want to activate the True Fan Cooking PLUS function, but the Plus Steam indicator does not switch on.	You did not select the heating function that support Plus Steam.	Refer to "Setting the function: True Fan Cooking PLUS".
You want to activate the True Fan Cooking PLUS function, but the Plus Steam indicator does not switch on.	The Plus Steam does not work.	Deactivate the appliance with the house fuse or the safety switch in the fuse box and activate it again. Refer to "Setting the function: True Fan Cooking PLUS".
The water in the cavity embossment does not boil.	The temperature is too low.	Set the temperature at least to 110 °C. Refer to "Hints and tips" chapter.
The water comes out of the cavity embossment.	There is too much water in the cavity embossment.	Deactivate the oven and make sure that the appliance is cold. Wipe the water with a cloth or sponge. Add the correct amount of water to the cavity embossment. Refer to the specific procedure.

12.2 Service data

If you cannot find a solution to the problem yourself, contact your dealer or an Authorised Service Centre.

The necessary data for the service centre is on the rating plate. The rating plate is

on the front frame of the oven cavity. Do not remove the rating plate from the oven cavity.

We recommend that you write the data here:

Model (MOD.)
Product number (PNC)
Serial number (S.N.)

13. ENERGY EFFICIENCY

13.1 Product Information and Product Information Sheet*

Supplier's name	AEG	
Model identification	BEB351010M 944187978,944188349 BEB351010W 944187979,944188350	
Energy Efficiency Index	95.3	
Energy efficiency class	A	
Energy consumption with a standard load, conventional mode	0.99 kWh/cycle	
Energy consumption with a standard load, fan-forced mode	0.81 kWh/cycle	
Number of cavities	1	
Heat source	Electricity	
Volume	71 l	
Type of oven	Built-In Oven	
Mass	BEB351010M	34.0 kg
	BEB351010W	34.0 kg

* For European Union according to EU Regulations 65/2014 and 66/2014.
For Republic of Belarus according to STB 2478-2017, Appendix G; STB 2477-2017, Annexes A and B.
For Ukraine according to 568/32020.

Energy efficiency class is not applicable for Russia.

EN 60350-1 - Household electric cooking appliances - Part 1: Ranges, ovens, steam ovens and grills - Methods for measuring performance.

13.2 Energy saving



The oven contains features which help you save energy during everyday cooking.

Make sure that the oven door is closed properly when the oven operates. Do not open the door too often during cooking. Keep the door gasket clean and make sure it is well fixed in its position.

Use metal cookware to improve energy saving.

When possible, do not preheat the oven before cooking.

Keep breaks between baking as short as possible when you prepare a few dishes at one time.

Cooking with fan

When possible, use the cooking functions with fan to save energy.

Residual heat

When the cooking duration is longer than 30 minutes, reduce the oven temperature to minimum 3 - 10 minutes

before the end of cooking. The residual heat inside the oven will continue to cook.

Use the residual heat to warm up other dishes.

Keep food warm

Choose the lowest possible temperature setting to use residual heat and keep a meal warm.

Moist Baking

Function designed to save energy during cooking.

14. ENVIRONMENTAL CONCERNS

Recycle materials with the symbol . Put the packaging in relevant containers to recycle it. Help protect the environment and human health by recycling waste of electrical and electronic appliances. Do not dispose of

appliances marked with the symbol  with the household waste. Return the product to your local recycling facility or contact your municipal office.

www.aeg.com/shop



867 336370-F-332019



AEG